

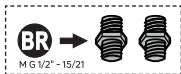

Guarantee  
**5**  
years

ANDERS

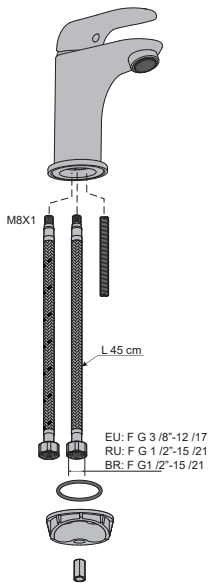

EAN CODE: 3276007184211  
3276007184228  
3276007184235

**FR** Notice de Montage -  
Utilisation - Entretien

**ES** Instrucciones de Montaje,  
Utilización y Mantenimiento

**PT** Instruções de Montagem,  
Utilização e Manutenção

**IT** Istruzioni per il Montaggio,  
l'Uso e la Manutenzione

**EL** Εγχειρίδιο συναρμολόγησης,  
χρήσης και συντήρησης

**PL** Instrukcja Montażu,  
Użytkowania i Konserwacji

**RU** Руководство По Сборке  
и Эксплуатации

**KZ** Жинау, пайдалану және  
техникалық қызмет  
көрсету нұсқаулығы

**UA** Керівництво По Збірці  
і Експлуатації

**RO** Manual asamblare,  
utilizare și întreținere

**BR** Instruções de Montagem,  
Utilização e Manutenção

**EN** Assembly - Use -  
Maintenance Manual

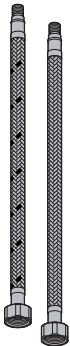
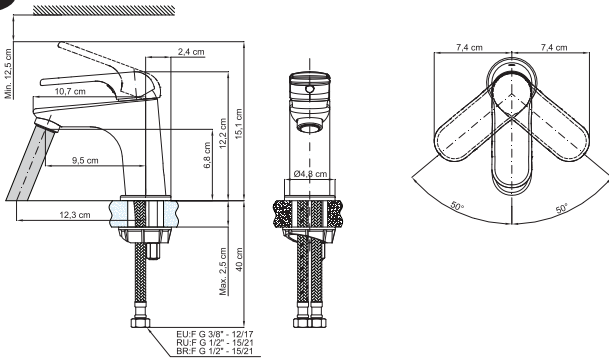

C

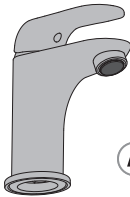

A



B



D



E



F

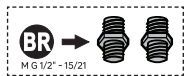



FR: Préparation / ES: Preparación / PT: Preparação / IT: Preparazione / EL: Προετοιμασία /  
 PL: Przygotowanie / RU: Подготовка / KZ: Дайындау / UA: Підготування / RO: Pregătire / BR: Preparação /  
 EN: Preparation



FR: Montage / ES: Montaje / PT: Montagem / IT: Montaggio / EL: Συναρμολόγηση /  
 PL: Montaż / RU: Сборка / KZ: Монтаждау / UA: Збірка / RO: Montaj / BR: Montagem /  
 EN: Assembly



FR: Utilisation eau chaude-eau froide/ ES: Utilización agua caliente-agua fría/ PT: Utilização água quente-água fria/  
 IT: Uso acqua calda-acqua fredda/ EL: Χρήση ζεστού-κρύου νερού/ PL: Użytkowanie zimnej wody-gorącej wody/  
 RU: использование горячей и холодной воды/ KZ: Суық және ыстық суды қолдану/  
 UA: використання гарячої - холодної води/ RO: Utilizare apă caldă-apă rece/ BR: Uso de água quente e fria/  
 EN: Using hot and cold water



FR: Changement de cartouche/ ES: Cambio de cartucho/ IT: Cambio cartuccia/ PT: Mudança de cartucho/  
 EL: Αλλαγή φουγγιού/ PL: Wymiana wkładu / RU: Смена картриджа/ KZ: Картриджді ауыстыру/  
 UA: Заміна картриджа/ RO: Schimbare cartuş / BR: Substituição de cartucho/ EN: Replacing the cartridge



FR: Changement de mousseur/ ES: Cambio de aireador/ PT: Mudança de arejador/ IT: Cambio rompigoetto/  
 EL: Αλλαγή αεράτορα/ PL: Wymiana perlatora / RU: Смена аэратора/ KZ: Ауақанықтырғышты ауыстыру/  
 UA: Заміна аэратора/ RO: Schimbare aerator/ BR: Substituição do aerador/ EN: Replacing the aerator



FR: Changement de flexibles/ ES: Cambio de flexibles / PT: Mudança de flexíveis/ IT: Cambio flessibili/  
 EL: Αλλαγή λάστιχων/ PL: Wymiana wężyków instalacyjnych / RU: Смена гибкого шланга для смесителя/  
 UA: Заміна гнучкого шланга для змішувача/ KZ: Қоспалауышқа арналған иілгіш шлангты ауыстыру/  
 RO: Schimbare furtune flexibile/ BR: Substituição das mangueiras/ EN: Replacing the hoses

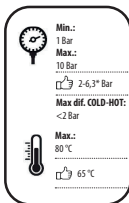
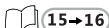

FR:\* Si la pression est supérieure à 5 bars, il est nécessaire de rajouter un réducteur de pression / ES:\*  
 Si la presión es superior a 5 bars, es necesario añadir un reductor de presión. / PT:\* Se a pressão for  
 superior a 5 bars, será necessário acrescentar um redutor de pressão / IT:\* Se la pressione è superiore  
 a 5 bar, bisogna aggiungere un riduttore di pressione / EL:\* Εάν η πίεση υπερβαίνει τα 5 bars, είναι  
 απαραίτητη η προσθήκη μειωτή πίεσης / PL:\* jeżeli ciśnienie jest wyższe niż 5 barów, należy dodać reductor  
 ciśnienia / RU:\* Если давление превышает 5 бар, необходимо добавить редуктор давления / KZ:\*  
 Егер қысым 5 бардан асатын болса, қысым бәсендеткішін қосу қажет / UA:\* Якщо тиск перевищує  
 5 бар, необхідно додати редуктор тиску / RO:\* Dacă presiunea este mai mare de 5 bar, este necesar  
 să adăuğiți un reductor de presiune / BR:\* Se a pressão for superior a 5 bar, é necessário adicionar um  
 reductor de pressão / EN:\* If the pressure is over 5 bars, a pressure reducing valve must be added.



FR: Préparation / ES: Preparación / PT: Preparação / IT: Preparazione / EL: Προετοιμασία /  
PL: Przygotowanie / RU: Подготовка / KZ: Дайындау / UA: Підготування / RO: Pregătire /  
BR: Preparação / EN: Preparation

1

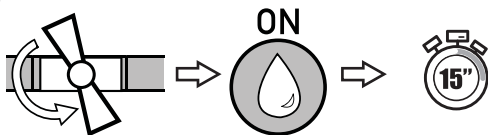

2

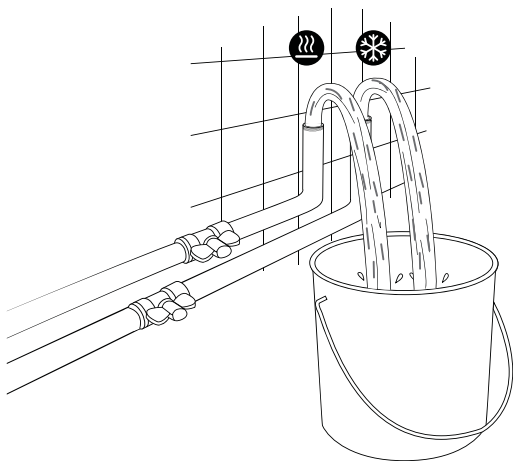

3

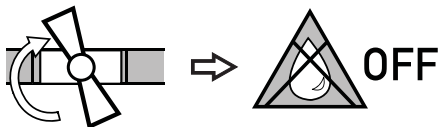

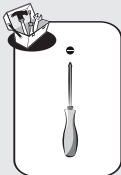
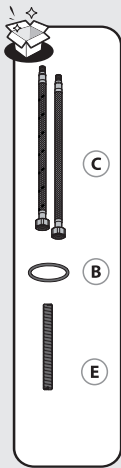

FR: Montage / ES: Montaje / PT: Montagem / IT: Montaggio / EL: Συναρμολόγηση /  
 PL: Montaż / RU: Сборка / KZ: Монтаждау / UA: Збірка / RO: Montaj / BR: Montagem /  
 EN: Assembly

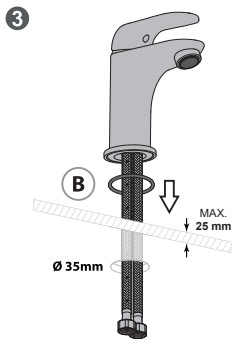
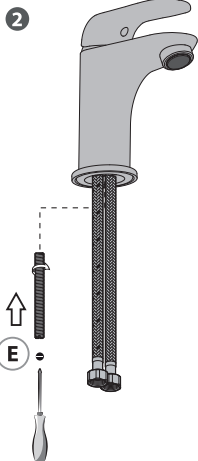
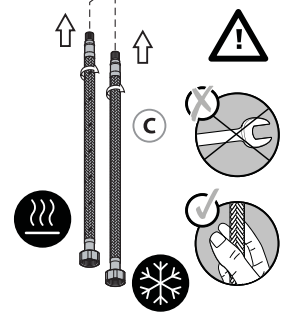
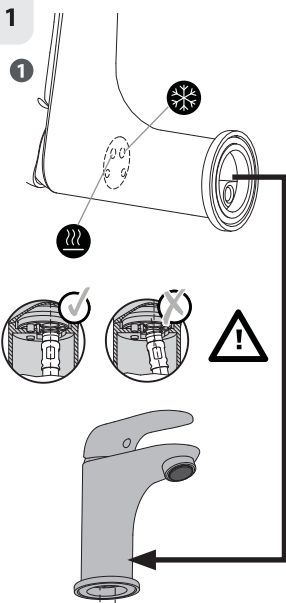



D



F



2

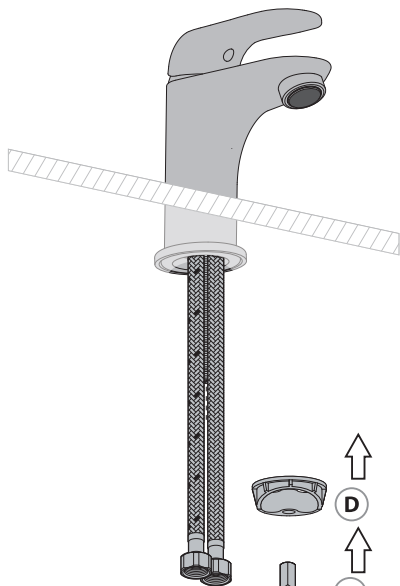

D



F

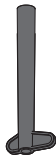

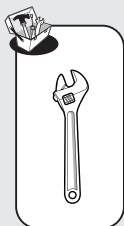

3

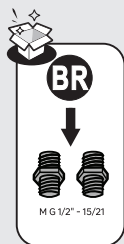
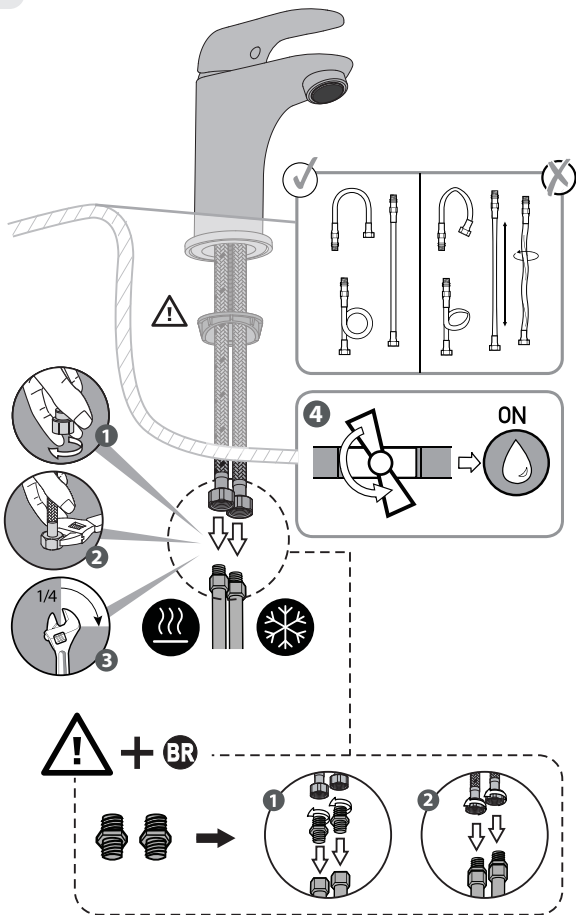



FR: Utilisation eau chaude-eau froide/ ES: Utilización agua caliente-agua fría/ PT: Utilização água quente-água fria/  
IT: Uso acqua calda-acqua fredda/ EL: Χρήση ζεστού-κρύου νερού/ PL: Użytkowanie zimnej wody-gorącej wody/  
RU: использование горячей и холодной воды/ KZ: Суық және ыстық суды қолдану/  
UA: використання гарячої - холодної води/ RO: Utilizare apă caldă-apă rece/ BR: Uso de água quente e fria/  
EN: Using hot and cold water

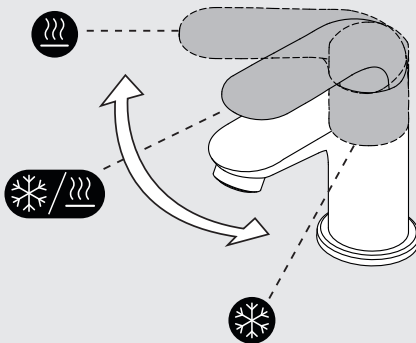
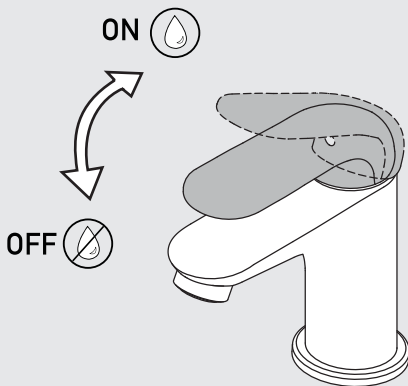



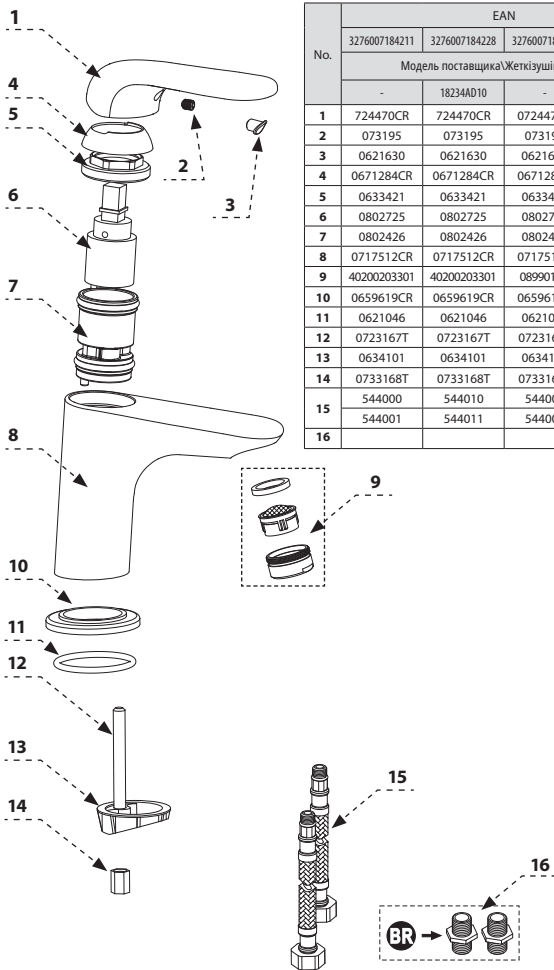

No.	EAN				QTY
	3276007184211	3276007184228	3276007184235	-	
	Модель поставщика\Жеткізушінің моделі:				
	-	18234AD10	-	-	
1	724470CR	724470CR	0724470N	724470CR	1
2	073195	073195	073195	073195	1
3	0621630	0621630	0621630	0621630	1
4	0671284CR	0671284CR	0671284N	0671284CR	1
5	0633421	0633421	0633421	0633421	1
6	0802725	0802725	0802725	0802725	1
7	0802426	0802426	0802426	0802426	1
8	0717512CR	0717512CR	0717512N	0717512CR	1
9	40200203301	40200203301	0899010N	40200203301	1
10	0659619CR	0659619CR	0659619N	0659619CR	1
11	0621046	0621046	0621046	0621046	1
12	0723167T	0723167T	0723167T	0723167T	1
13	0634101	0634101	0634101	0634101	1
14	0733168T	0733168T	0733168T	0733168T	1
15	544000	544010	544000	544010	2
	544001	544011	544001	544011	
16				0753325T	2



FR: Changement de cartouche/ ES: Cambio de cartucho/ IT: Cambio cartuccia/ PT: Mudança de cartucho/  
EL: Αλλαγή φιλτράριου/ PL: Wymiana wkładu / RU: Смена картриджа/ KZ: Картриджді ауыстыру/  
UA: Заміна картриджа/ RO: Schimbare cartuş/ BR: Substituição de cartucho/ EN: Replacing the cartridge

1



OFF

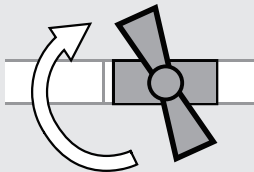

2

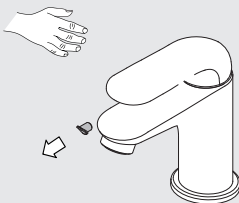

3

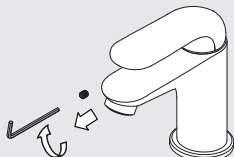

4

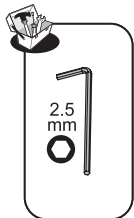
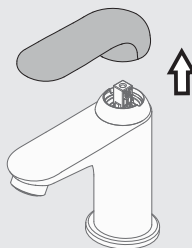

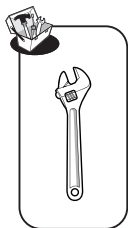

FR: Changement de cartouche/ ES: Cambio de cartucho/ IT: Cambio cartuccia/ PT: Mudança de cartucho/  
EL: Αλλαγή φρεσγιγιού/ PL: Wymiana wkładu / RU: Смена картриджа/ KZ: Картриджді ауыстыру/  
UA: Заміна картриджа/ RO: Schimbare cartuş/ BR: Substituição de cartucho/ EN: Replacing the cartridge

5

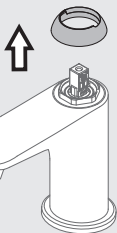

6

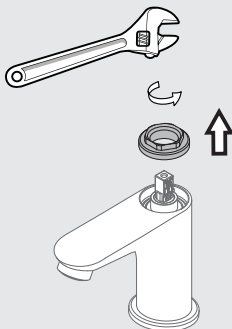

7

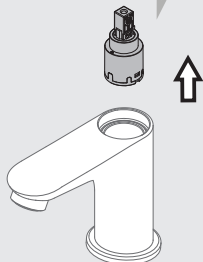

8

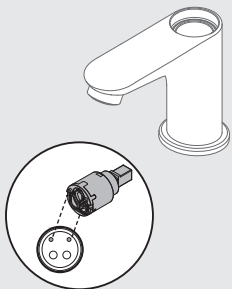

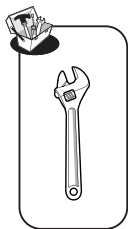

FR: Changement de cartouche/ ES: Cambio de cartucho/ IT: Cambio cartuccia/ PT: Mudança de cartucho/  
EL: Αλλαγή φιοτιγγίου/ PL: Wymiana wkładu / RU: Смена картриджа/ KZ: Картриджді ауыстыру/  
UA: Заміна картриджа/ RO: Schimbare cartuş/ BR: Substituição de cartucho/ EN: Replacing the cartridge

9

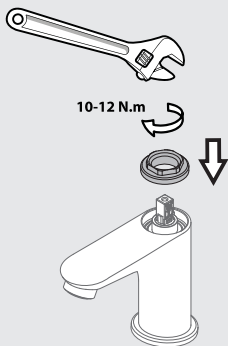

10

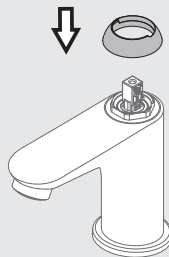

11

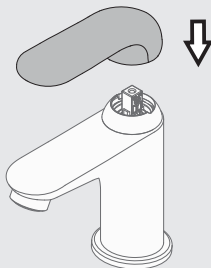

12

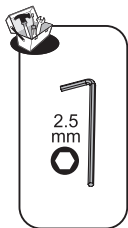
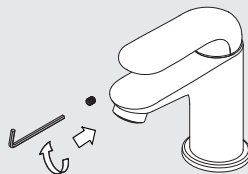



FR: Changement de cartouche/ ES: Cambio de cartucho/ IT: Cambio cartuccia/ PT: Mudança de cartucho/  
EL: Αλλαγή φιλτρίγιου/ PL: Wymiana wkładu / RU: Смена картриджа/ KZ: Картриджді ауыстыру/  
UA: Заміна картриджа/ RO: Schimbare cartus/ BR: Substituição de cartucho/ EN: Replacing the cartridge

13



14

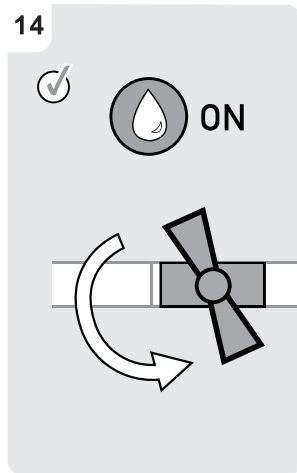

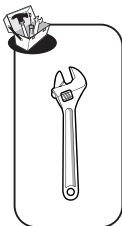

FR: Changement de mousseur/ ES: Cambio de aireador/ PT: Mudança de arejador/ IT: Cambio rompigitto/  
 EL: Αλλαγή αεράτορα / PL: Wymiana perlatora / RU: Смена аэратора/ KZ: Ауақанықстырғышты ауыстыру/  
 UA: Заміна аератора/ RO: Schimbare aerator/ BR: Substituição do aerador/ EN: Replacing the aerator

1



2

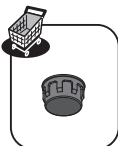
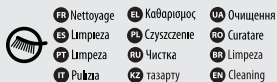

3

FR	Vinaigre	IT	Aceto	RU	Уксус	RO	Oțet
ES	Vinagre	EL	Εξόδι	KZ	Сірке су	BR	Vinagre
PT	Vinagre	PL	Ocet	UA	Оцет	EN	Vinegar

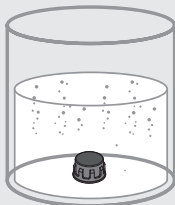

4



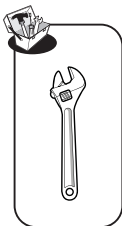

FR: Changement de flexibles/ ES: Cambio de flexibles/ PT: Mudança de flexíveis/ IT: Cambio flessibili/  
EL: Αλλαγή λάστιχων/ PL: Wymiana wężyków instalacyjnych/ RU: Смена гибкого шланга для смесителя/  
UA: Заміна гнучкого шланга для змішувача/ KZ: Қоспалауышқа арналған иілгіш шлангты ауыстыру/  
RO: Schimbare furtune flexibile/ BR: Substituição das mangueiras/ EN: Replacing the hoses

1

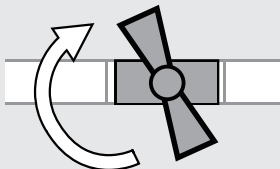

2

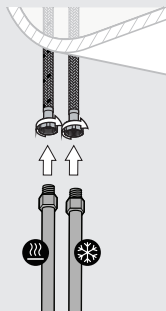

3

ON



4

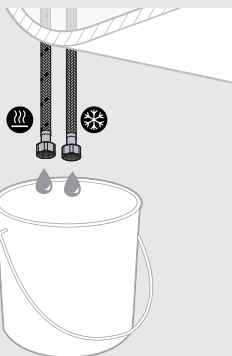

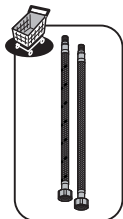
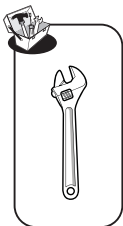

FR: Changement de flexibles/ ES: Cambio de flexibles/ PT: Mudança de flexíveis/ IT: Cambio flessibili/  
EL: Αλλαγή λόστιχων/ PL: Wymiana wężyków instalacyjnych/ RU: Смена гибкого шланга для смесителя/  
UA: Заміна гнучкого шланга для змішувача/ KZ: Қоспалауышқа арналған иілгіш шлангты ауыстыру/  
RO: Schimbare furtune flexibile/ BR: Substituição das mangueiras/ EN: Replacing the hoses

5

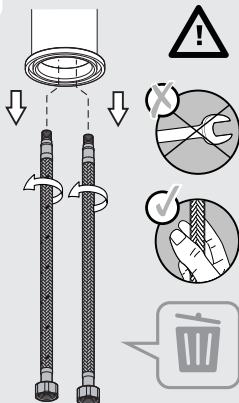

6

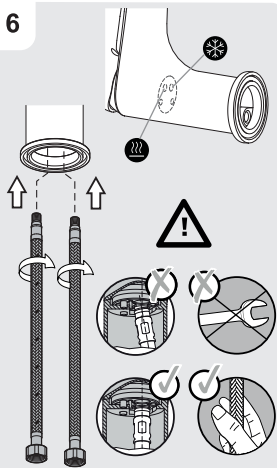

7

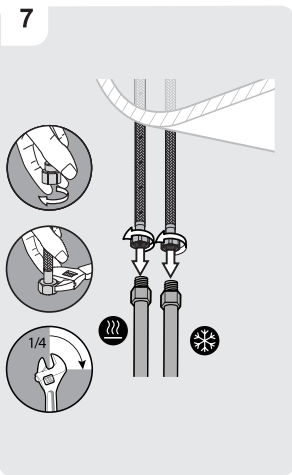

8

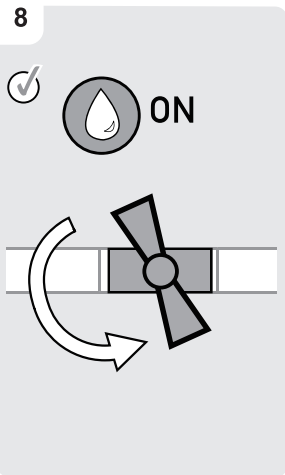





Eau claire / Agua limpia / Água limpa / Acqua pulita / Καθαρό νερό / Czysta woda / Чистая вода / Água limpa /  
Чиста вода / Ara curata / таза су / Clean water



Sans solvant / Sin disolvente / Sem solventes / Senza solventi / Χωρίς διαλυτικά / Bez rozpuszczalnika / Без растворителя /  
Sem solventes/ Без розчинника / Fara solvent / еріткішчіз/ Solvent-free

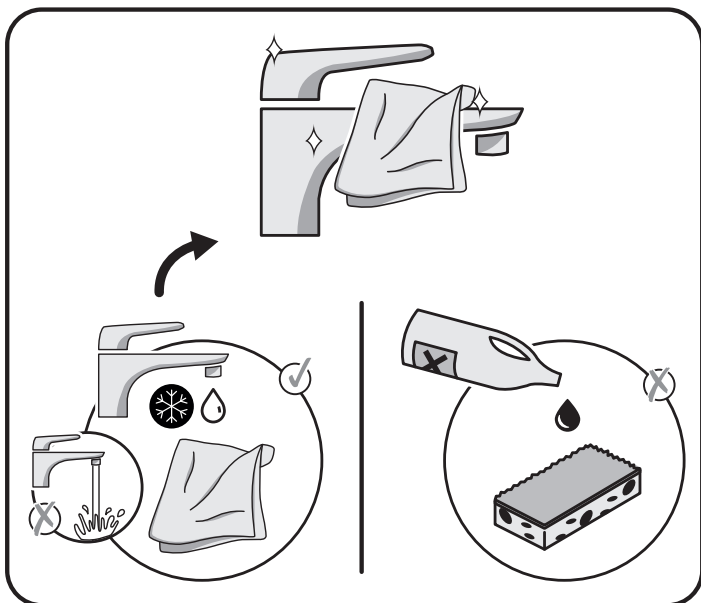

- FR** Pour une consommation d'eau adaptée, ce robinet est équipé d'un mousseur à économie d'eau.
- ES** Este grifo cuenta con un aireador de ahorro de agua para un adecuado consumo de agua.
- PT** Para um consumo adequado de água, esta torneira está equipada com um arejador que economiza água.
- IT** Per un consumo d'acqua più adatto, questo rubinetto dispone di un rompigetto per economizzare l'acqua.
- EL** Για μια καλά ρυθμισμένη κατανάλωση νερού, αυτή η μπαταρία είναι εξοπλισμένη με ένα φίλτρο εξοικονόμησης νερού.
- PL** Aby zapewnić optymalne zużycie wody, kran ten jest wyposażony w perlator oszczędzający wodę.
- RU** Для правильного потребления воды этот кран оснащен водосберегающим аэратором.
- KZ** Суды дұрыс тұтыну мақсатында бұл шүмек суды үнемдейтін аэратормен жабдықталған.
- UA** Для правильного споживання води цей кран оснащений водозберігаючим аератором.
- RO** Pentru un consum adecvat de apă, acest robinet este echipat cu un aerator de economisire a apei.
- BR** Para um consumo adequado de água, essa torneira está equipada com um aerador para economia de água.
- EN** For an adequate water consumption, this tap is fitted with an eco aerator for water savings.





- FR** Attestation de conformité sanitaire
- ES** Certificado de conformidad sanitaria.
- PT** Atestado de conformidade sanitária.
- IT** certificato di conformità sanitaria.
- EL** Βεβαίωση υγειονομικής συμμόρφωσης.
- PL** Certyfikat zgodności sanitarnej.
- RU** Декларация о соответствии санитарным нормам
- KZ** Санитарлық талаптарға сәйкестік декларациясы
- UA** Декларація про відповідність санітарним нормам
- RO** Atestat de conformitate sanitară
- BR** Certificado de conformidade sanitária.
- EN** Declaration of sanitary conformity.



\* Garantie 5 ans / 5 años de garantía / Garantia de 5 anos / Garanzia 5 Anni / Εγγύηση 5 ετών /  
Gwarancja 5-letnia / Гарантия 5 года / Келіпдік 5 жыл / Гарантія 5 років / Garantie 5 anni /  
5-year guarantee

2020

**FR** ADEO Services - 135 Rue Sadi Carnot - CS 00001  
59790 RONCHIN - France

**UA** ТОВ «Леруа Мерлен Україна»,  
вул. Полярна 17а, м. Київ 04201, Україна

**RU** ООО ЛЕРУА МЕРЛЕН ВОСТОК, 141031, Московская  
область, г. Мытищи, Осташковское шоссе, д.1, РОССИЯ

**BR** Importado e distribuído por LEROY MERLIN  
C/À BRASILEIRA DE BRICOLAGEM  
Rua Domingas Galleri Blotta, 315 - Interlagos - CEP  
04455-360 São Paulo - SP - Brazil CNPJ: 01.438.784/0001-05  
CALM (Central de Atendimento Leroy Merlin) -40.20.5376 (capitals)  
e 0800.0205376 (demais regiões)

**SA** Imported by Adeo South Africa (PTY) LTD T/A Leroy Merlin  
Leroy Merlin Greenstone Store - Corner Blackrock Street  
and Stoneridge Drive, Greenstone Park Ext 2,  
Edenvale, 1610 - Johannesburg, Gauteng, South Africa

**KZ** «Леруа Мерлен Қазақстан» ЖШС Қазақстан  
Республикасы, 050000, Алматы қ., Қонаев  
көшесі, 77, «ParkView» БО, ӨК, 07 сф.

**BY** Поставщик/импортер/организация, принимающая  
претензии по качеству товара в Республике Беларусь:  
ООО «Леруа Мерлен Бел», 220020, Республика Беларусь,  
г. Минск, пр-т Победителей, д. 100, каб. 503



HI415P